

Optical Spectroscopy

Virginia Lorenz, Kai Wen Teng

PHYS 403 Spring 2022

Electromagnetic Spectrum of atoms and molecules

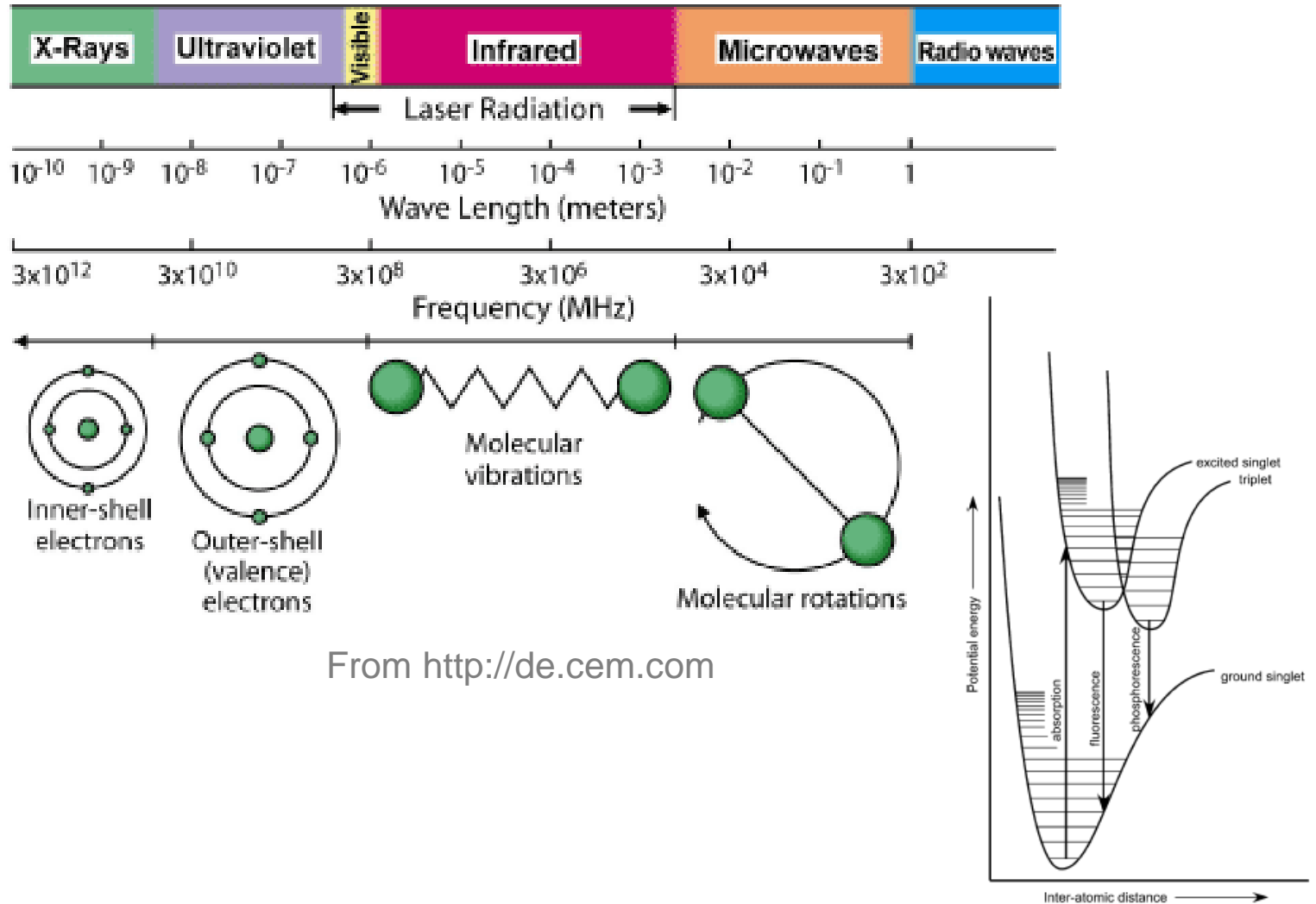

From <http://de.cem.com>

Types of Fluorescent Molecules

Synthetic Organic:
Fluorescein

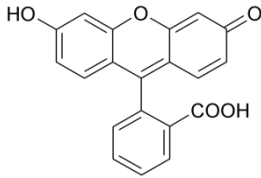

Naturally Occuring:

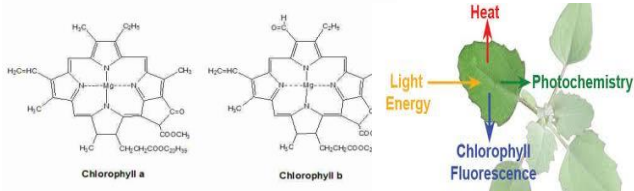

Fluorescent Proteins:

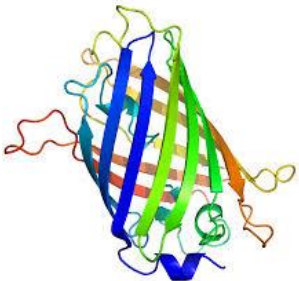

Green Fluorescent Protein

Semiconductor Nanocrystal:

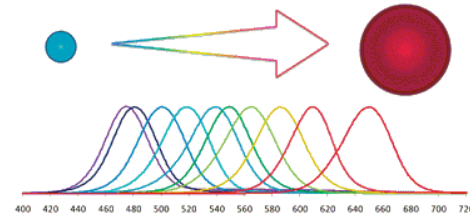
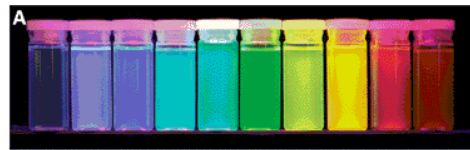
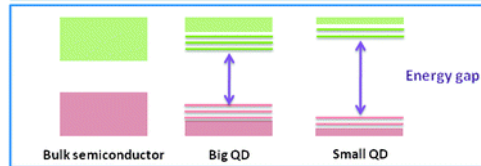
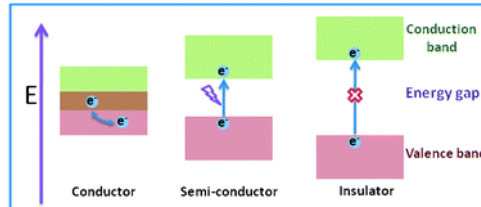
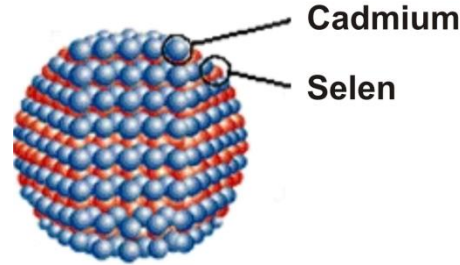
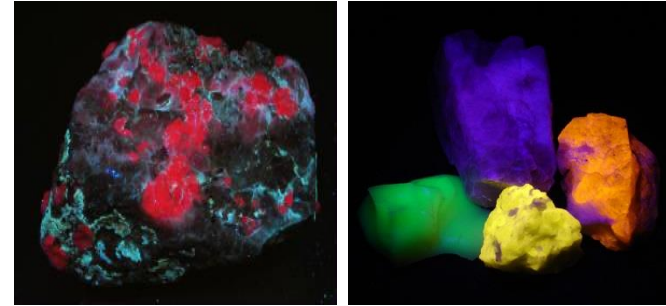

Image from Zrazhevskiy et al. 2010

Crystals:



Ruby and assorted minerals

From mineralman.net

Fluorescent Nanodiamonds

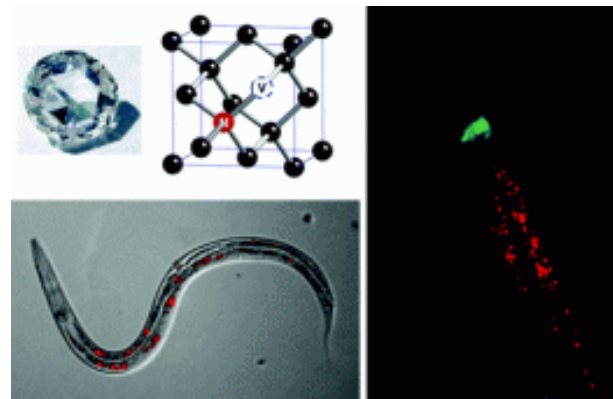

Nano Lett., 2010, 10 (9), pp 3692-3699. DOI: 10.1021/nl1021909

Perrin-Jablonski energy diagram

illustrates the electronic states of a molecule and the transitions between them



Alexander Jabłoński
1898-1980

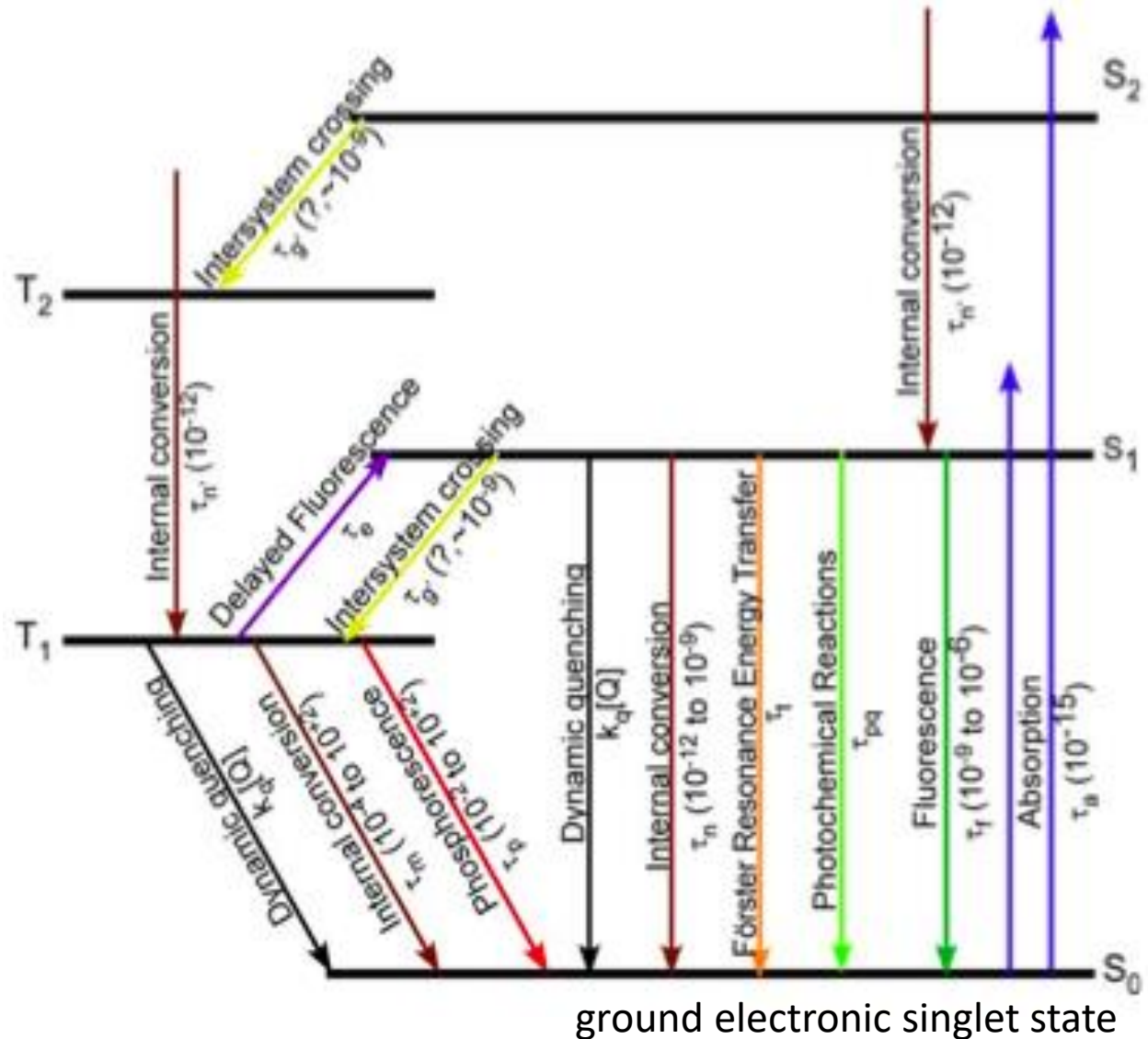

Absorption ($S_0 \rightarrow S_1$)

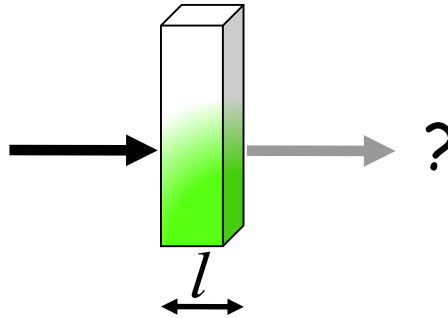

Beer-Lambert's Law

$$\log(I_0) - \log(I) = \epsilon c l$$

Extinction coefficient:

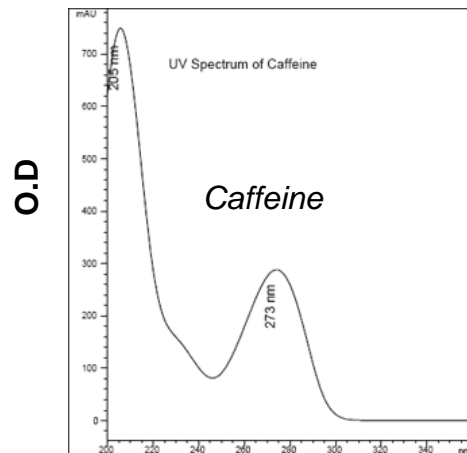

Concentration

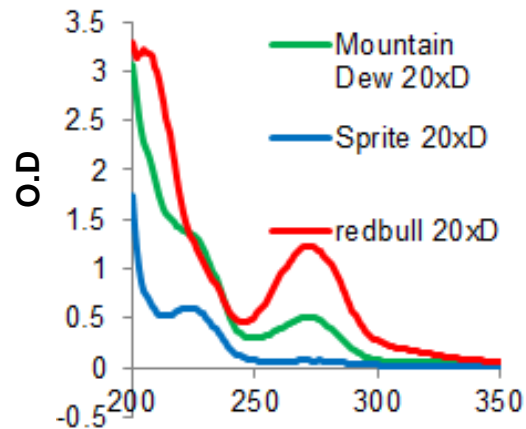

Steady State Measurements: Absorbance

One of the very first commercially available instruments that measures absorbance was the Beckman DU spectrophotometer

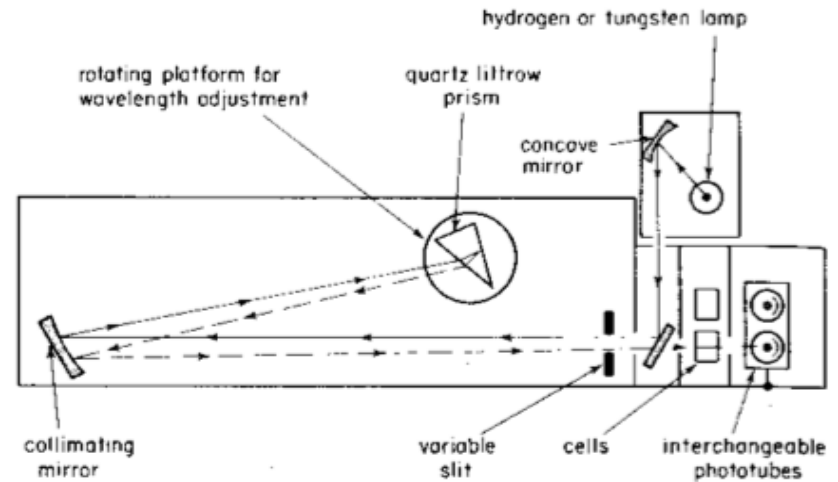

Machines nowadays that utilize diffraction grating and diode array detector can acquire an absorbance spectra in less than 10 seconds.

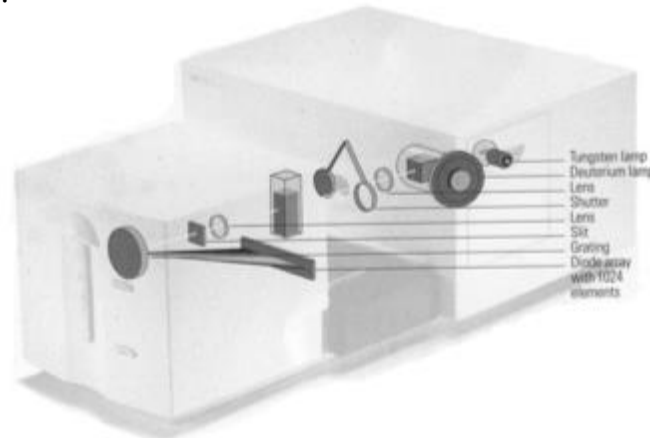

Fluorescence ($S_1 - S_0$)

Solvent Effect:

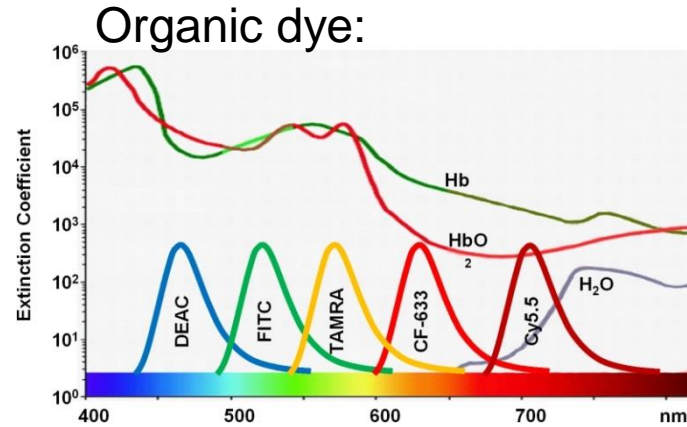

Fluorophore-Solvent Excited State Interactions

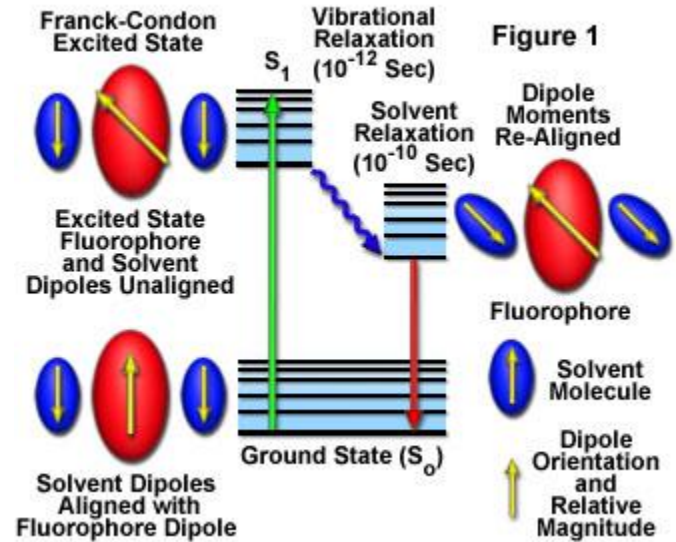

Ruby:

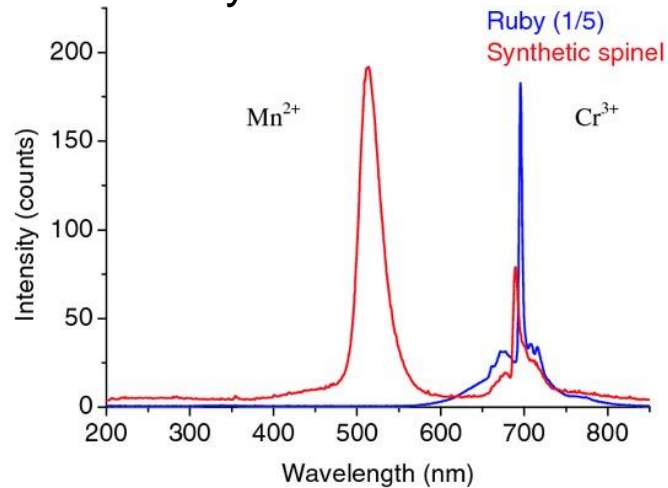

<http://micro.magnet.fsu.edu>

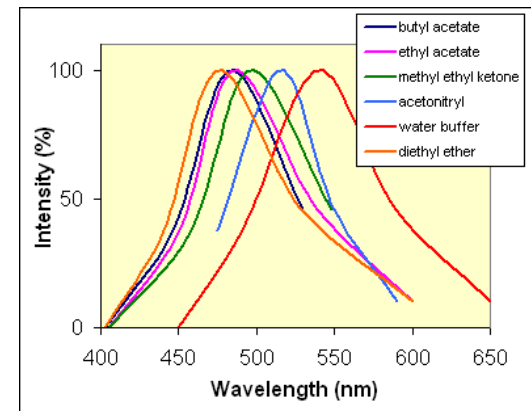

<http://www.bio.davidson.edu>

Time-Dependent Fluorescence: Fluorescence Lifetime

Fluorescence Lifetime: The average amount of time a molecule stays in excited state

Probability of being in the excited state

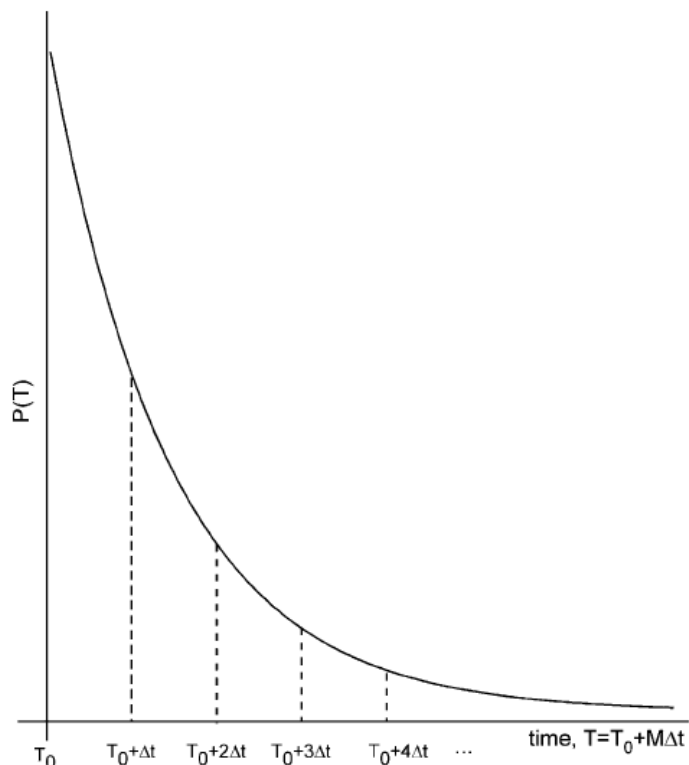

k_f = rate constant for leaving excited state while emitting a photon

k_i = rate constant for leaving excited state through other means (ie. Dynamic quenching, Energy Transfer, etc)

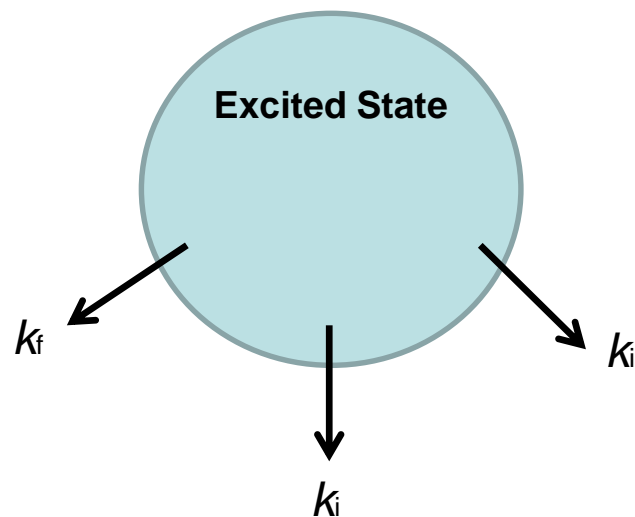

Fluorescence Lifetime: $\frac{1}{\tau} = \sum_i k_i$

Lifetime is sensitive to other decaying pathways present!

The Bolognian Stone

http://www.isbc.unibo.it/Files/10_SE_BoStone.htm



Marc Antonio Cellio (1680) representing the light emission of heated barite

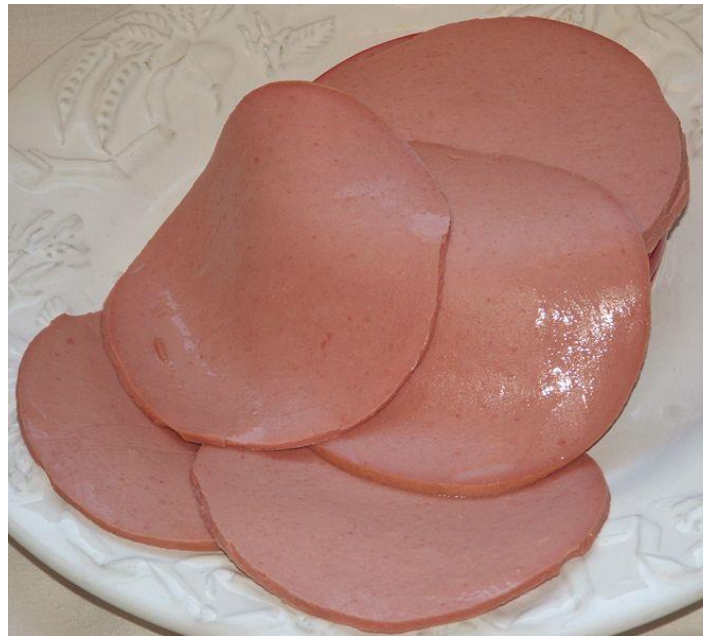

It is now a long time since the cobbler of Bologna, in Italy, astonished and amused his friends with a peculiar substance since known as *Bologna phosphorus*, *Bologna stone*, or *Solar phosphorus*, which shines brightly in the dark after having been placed in the sunlight for some time. This substance is sulphuret of barium. The cobbler prepared it by heating red-hot with charcoal a piece of *sulphate of baryta*, or *Barytine*, (Fig. 1,) a stone which he



Fig. 1.

picked up in the secondary strata of the Monte Paterno, where he found it in lumps of considerable weight.* The German chemist, Marggraf, used to prepare solar phosphorus by powdering down the stone, and making it into thin cakes, with a mixture of flour and water, before submitting it to calcination. This "Bologna phosphorus" was the first substance known to become phosphorescent after insolation, and, consequently, it has been

1870.

T. L. PHIPSON, PH.D., F.C.S.

submitted to many and varied experiments. It is best obtained by the calcination of pulverized sulphate of baryta, made into a firm paste with common gum. It should be preserved in a bottle which closes hermetically with a glass stopper.

It will be easily understood what is meant by the term *Phosphorescence*, when we remind our readers that phosphorus, which shines so curiously in the dark, and which enters into the composition of our common lucifer matches, is the most remarkable of all phosphorescent bodies. The word "phosphorus," which signifies a substance that bears or emits a light, has frequently been applied to various other substances besides the non-metallic element termed *phosphorus* in chemistry, on account of the property these substances possess likewise of shining in the dark.

First mention of lifetimes?

"The Bologna stone, when placed in the sun attracts the rays, and retains them so long as to give light a considerable time after it is removed into the dark." *Goethe "The Sorrows of Werter"*

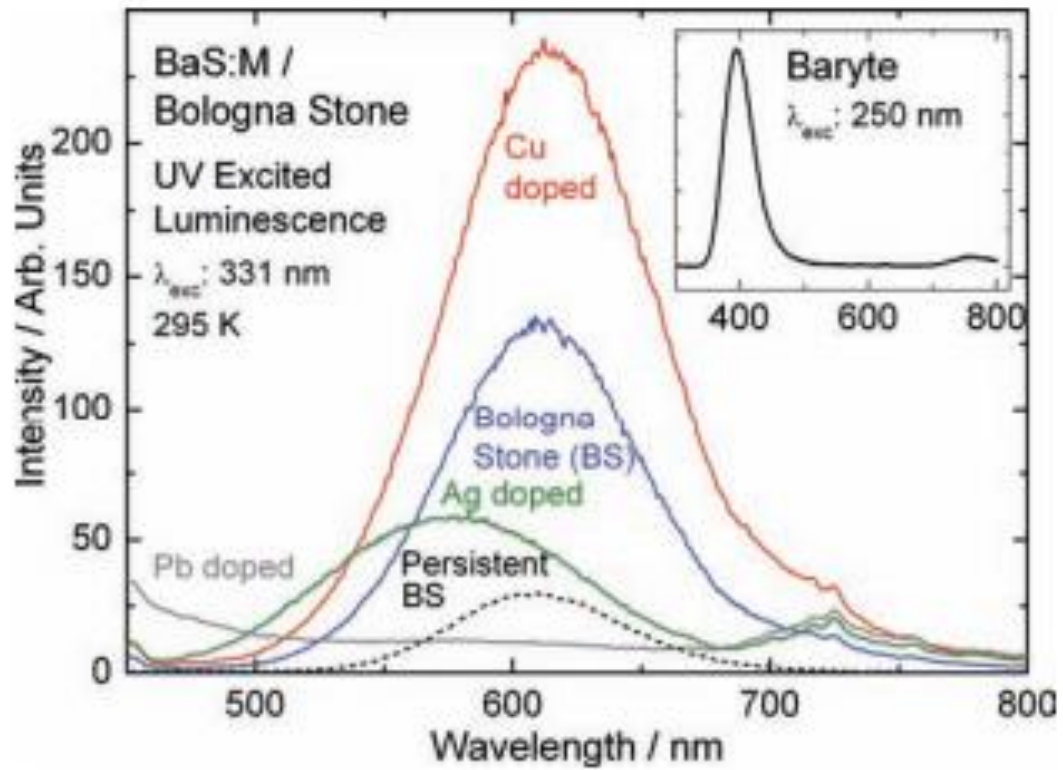

Lastusaari et al. 2011

Dr. Brand in 1674-5 attempted to distil human urine and in this way discovered phosphorus.

Phosphorus (Greek phosphoros was the ancient name for the planet Venus) was discovered by German alchemist Hennig Brand in 1669 through a preparation from urine. Working in Hamburg, Brand attempted to distill salts by evaporating urine, and in the process produced a white material that glowed in the dark and burned brilliantly.



Misnomer:
Phosphorescence
of phosphorous is
due to slow
oxidation

Painting by Joseph Wright of Derby (18th century) representing the discovery of the "phosphorescence" of the phosphorus extracted from urine by Hennig Brand in 1669

Measuring the Depletion of the excited state

$$[\# x^*] = [\# x_o^*] e^{-(k_F + k_t)t}$$

$$[\# x^*](k_F) = \text{Intensity that you measure}$$

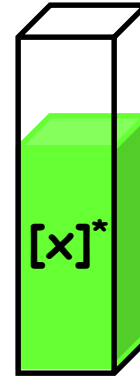

k_F is rate constant of fluorescence

Intensity measured is proportional to the # of molecules in the excited state!

Measuring Lifetime: Time Domain

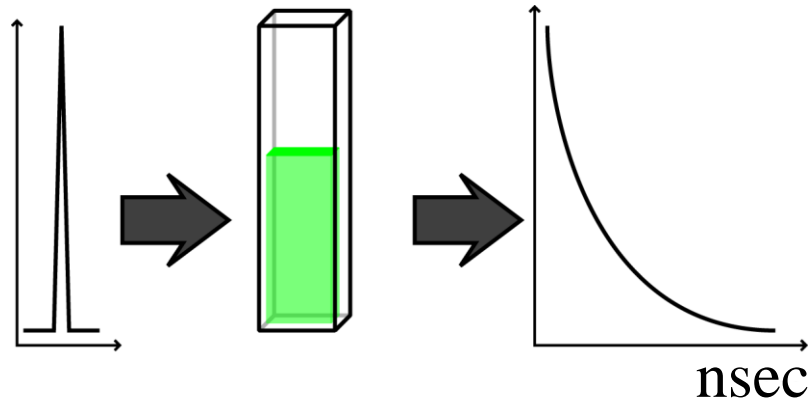

What do you need?

- Collect signal fast enough
- Fitting

Measuring Lifetime: Frequency Domain

$$E(t) = E_o + E_\omega \cos(\omega_E t + \varphi_E)$$

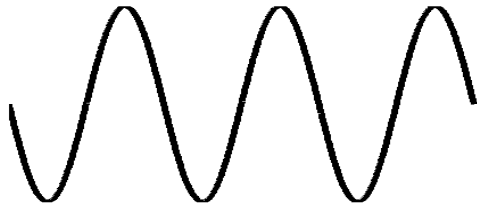

$$F(t) = F_o + F_\omega \cos(\omega_E t + \varphi_E - \varphi)$$

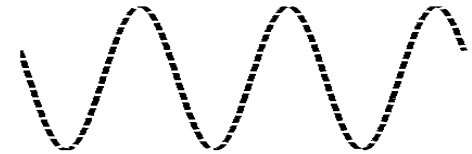

$$\tan(\varphi) = \omega_E \tau_\varphi$$

$$M = \frac{F_\omega / F_o}{E_\omega / E_o} = \frac{1}{\sqrt{1 + (\omega \tau_{Mod})^2}}$$

What do you need?

-Intensity modulators

-Synchronization

AOMs - Intensity Modulator

MEASUREMENTS OF SUBNANOSECOND FLUORESCENCE LIFETIMES WITH A CROSS-CORRELATION PHASE FLUOROMETER*

Richard D. Spencer and Gregorio Weber
 Department of Chemistry and Chemical Engineering
 University of Illinois
 Urbana, Ill.

Annals of the New York Academy of Sciences Vol. 158 pp 361-376, 1969

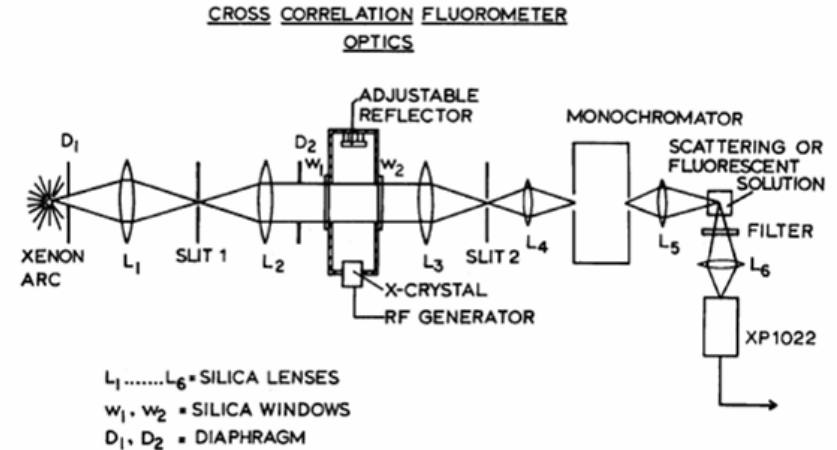

FIGURE 4. Plan of the optics of fluorometer.

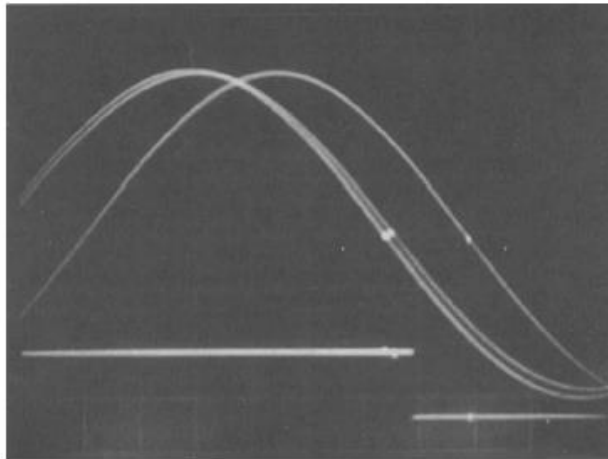

FIGURE 7. The figure shows the cross-correlation photocurrents from a scattering solution (first from left), a solution of NADH in phosphate buffer, pH 7.0, 17° C (second from left), and a solution of fluorescein (1 μgm/ml) in 0.01 M NaOH (right).

-modulation frequency limited by resonance frequency of the acousto-optic cell

-variations in the intensity modulation caused by temperature

Pockels Cell

A CONTINUOUSLY VARIABLE FREQUENCY CROSS-CORRELATION PHASE FLUOROMETER WITH PICOSECOND RESOLUTION

E. GRATTON AND M. LIMKEMAN

Department of Physics, University of Illinois at Urbana-Champaign, Urbana, Illinois 61801

Biophysical Journal Vol. 44 (1983) pp 315-324

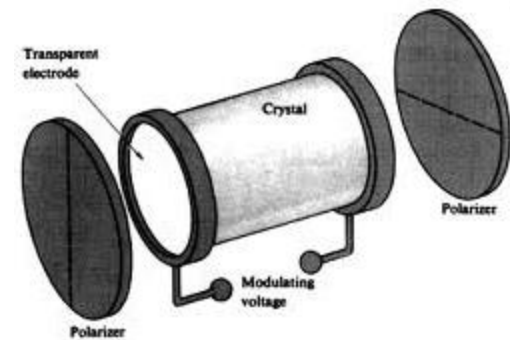
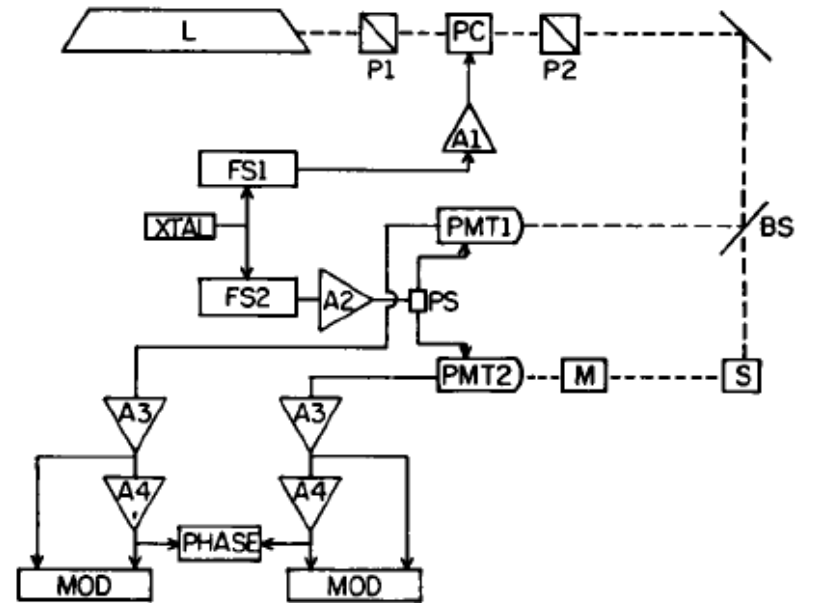

Figure 8.57 A Pockels cell.

Hecht Optics

Directly Modulated Diode



System in ESB

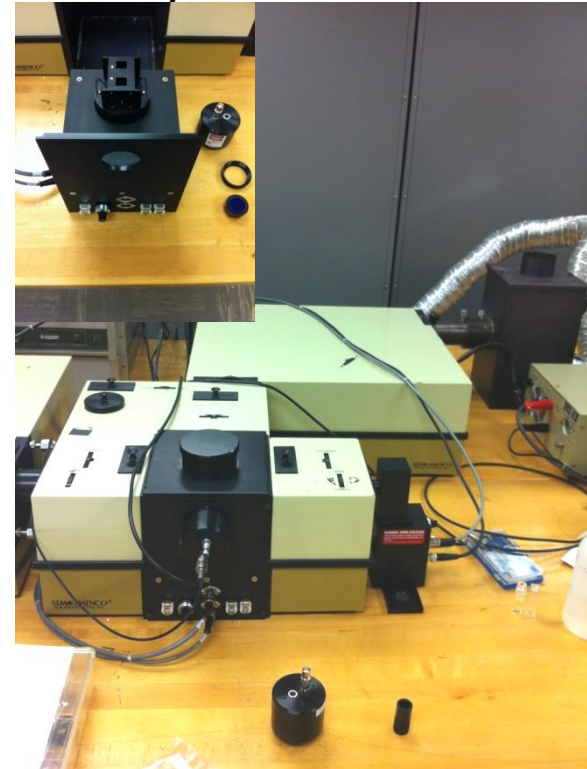

Laser Diodes -> (405nm,436nm,473nm,635nm,690nm,780nm,830nm)

LEDs -> (280nm,300nm,335nm,345nm,460nm,500nm,520nm)

Champaign, IL: domain of fluorescence lifetime imaging microscopy

**Robert Clegg - UIUC
Full-Field FLIM**



**Enrico Gratton - UIUC
Scanning Confocal FLIM (FLIMBox)**



**Beniamino Barbieri - ISS Inc.
Commercialization of FD FLIM**



Applications of Fluorescence in Biology

Fluorescence Lifetime Imaging on Live Cells

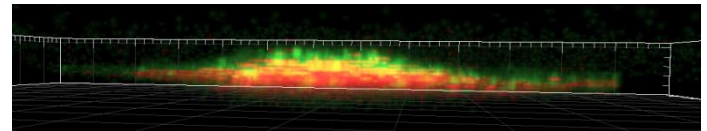
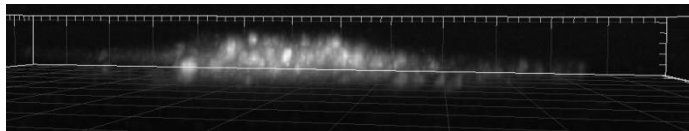
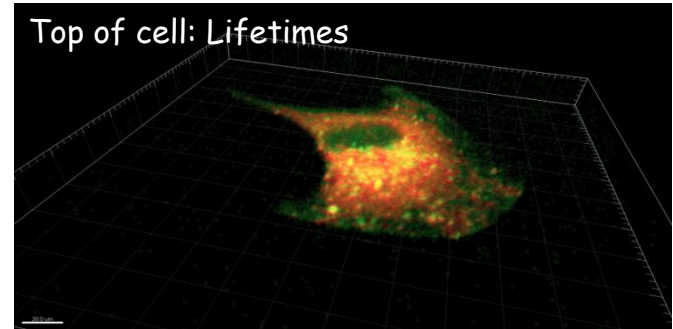
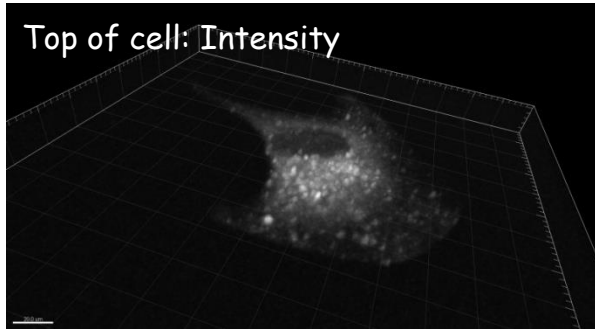

Optical Sections - Rendered by Lifetime

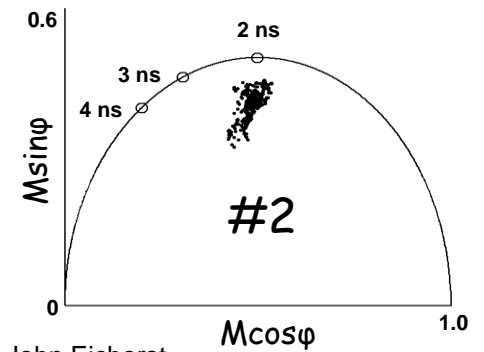
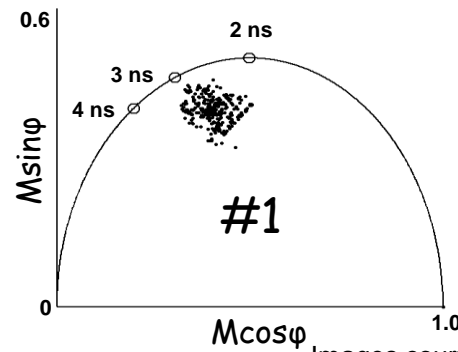
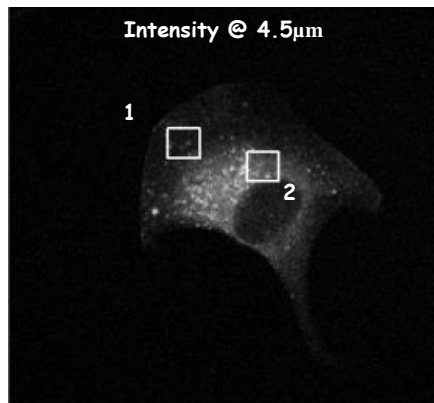
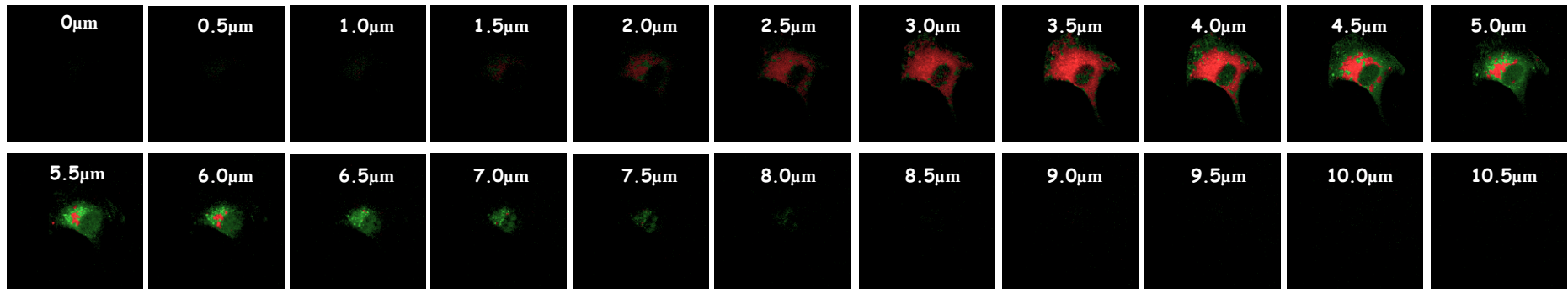

Single Molecule Fluorescence Imaging

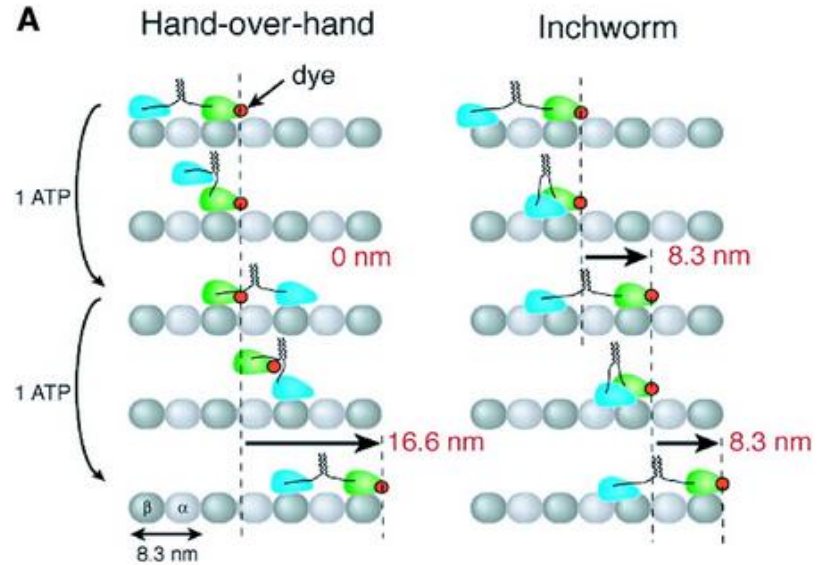
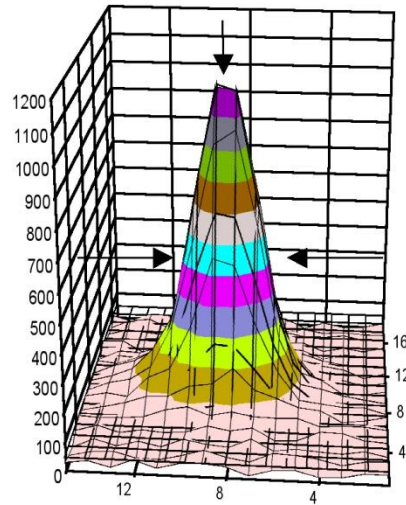
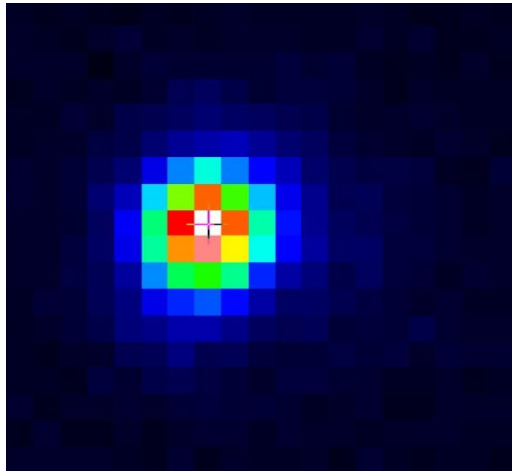

$$\sigma_{\mu_i} = \sqrt{\left(\frac{s_i^2}{N} + \frac{a^2/12}{N} + \frac{8\pi s_i^4 b^2}{a^2 N^2}\right)}$$

Center of the distribution can be determined in ~1.5 nm accuracy if #N is more than 10⁴

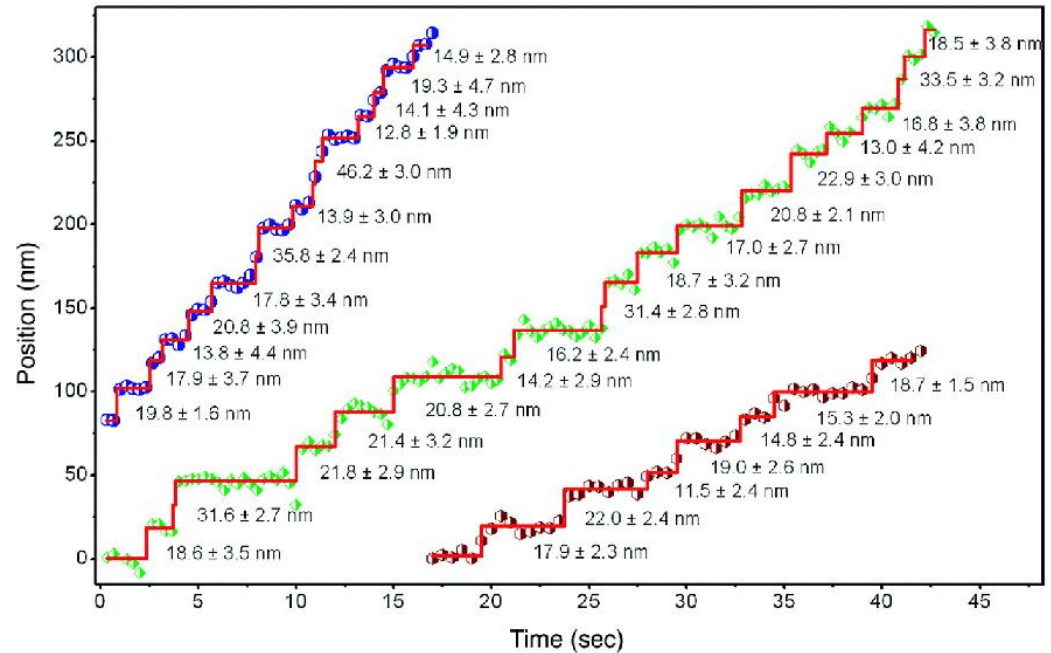

Super Resolution Fluorescence Imaging

Basic Principle of STORM Superresolution Imaging

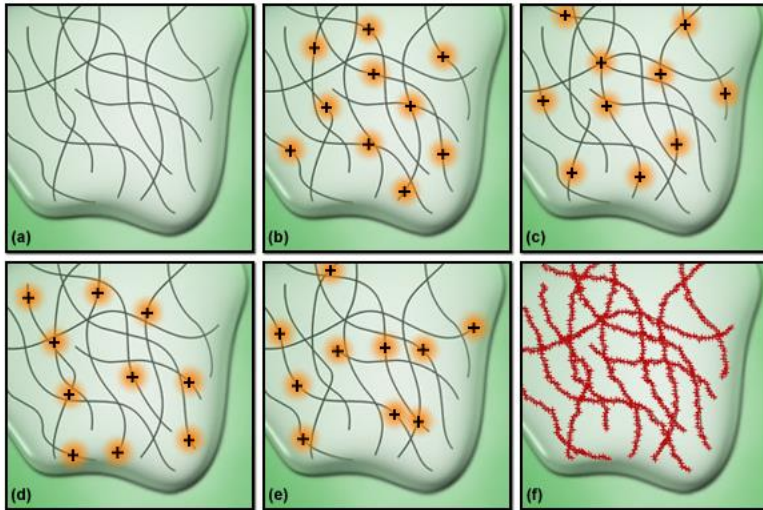

Three-Dimensional Superresolution Imaging with STORM

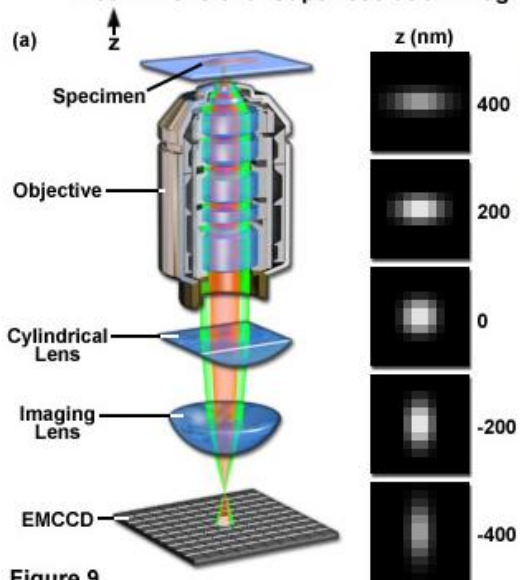

Figure 9

